

One for all ...

Since its introduction, the iBox universal has been the first and only basic set for Hansgrohe and Axor concealed manual and thermostatic solutions. Its features are just as varied as the number of possible uses. The iBox universal creates more space, freedom of movement and planning freedom in the bathroom – and is quick and easy to install. So it's no wonder, then, that the iBox universal has quickly become a firm favourite of the bathroom sector.

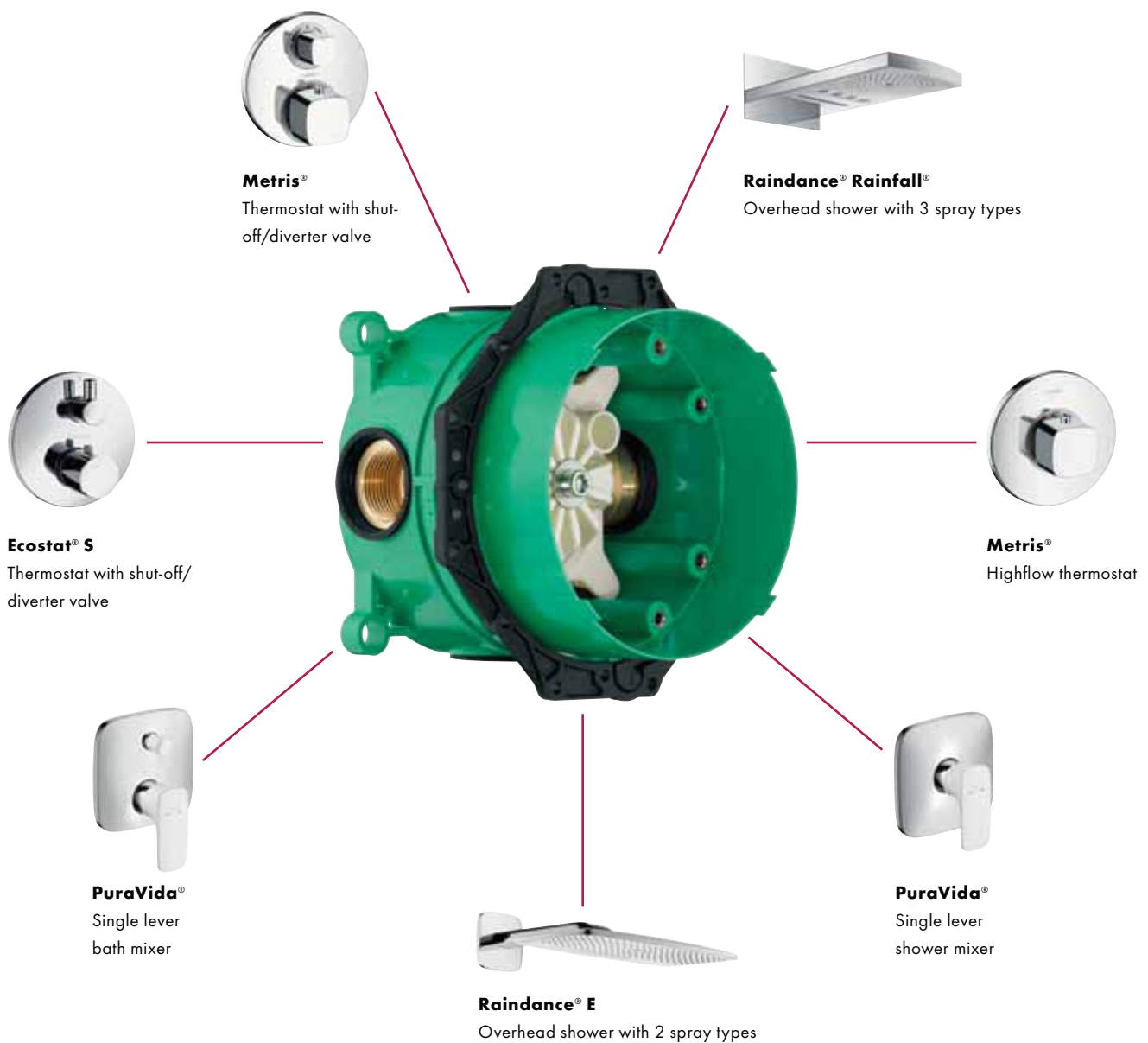

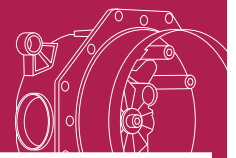

iBox® universal

The concealed system -
also for ShowerSelect®

... and select your Shower Pleasure

The iBox universal is the flexible concealed solution, which is also suitable for the latest milestone in Hansgrohe's history: **Select technology**. This provides greater shower pleasure from hand and overhead showers and surface-mounted thermostats because a simple touch of a button is all it takes to switch the mixer on and off, select or change the function or change the spray type. The innovative Select control concept is also available as a concealed solution in combination with the iBox universal using the new ShowerSelect finish sets.

Select your shower pleasure when:

- updating an bathroom with iBox universal as a basic set
- building a new house
- renovating or modernising

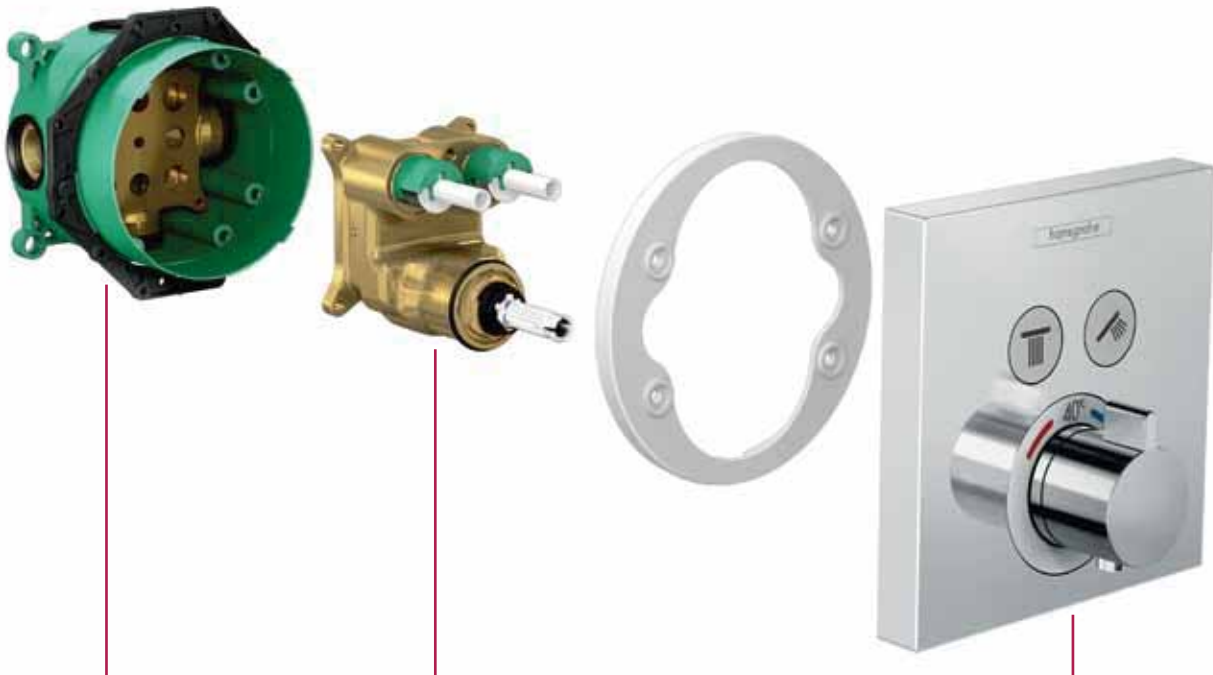

iBox® universal basic set

Functions block

ShowerSelect® finish set

Like all Hansgrohe concealed solutions, the new ShowerSelect finish sets are easy to fit to the iBox universal.

Concealed – the attractive way to fit a mixer

With the iBox universal, the mixer technology is concealed in the wall. This not only looks good, but also creates more space and so adds to the shower pleasure. Another feature is the flexibility of the design and system. The iBox universal can be installed before a shower system is chosen. As the basic set for any Hansgrohe concealed solution, it can be changed and upgraded at any time.



Surface-mounted installation

With a surface-mounted installation, the function unit is entirely in front of the wall – i.e. on the plaster. The disadvantage is that it takes up more space, which reduces the freedom of movement when showering.



Concealed installation

With concealed installation, the base unit is housed within the wall, i.e. behind the plaster. Mixers and shower finish sets from various Hansgrohe and Axor ranges can be fitted to it.

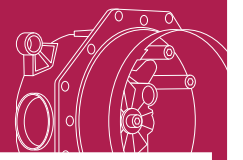

iBox® universal

Advantages of concealed assembly and iBox universal

iBox® universal: all-round appeal

The iBox universal is the first choice for concealed installation. See for yourself over the following pages just what the iBox universal has to offer you and your customers.

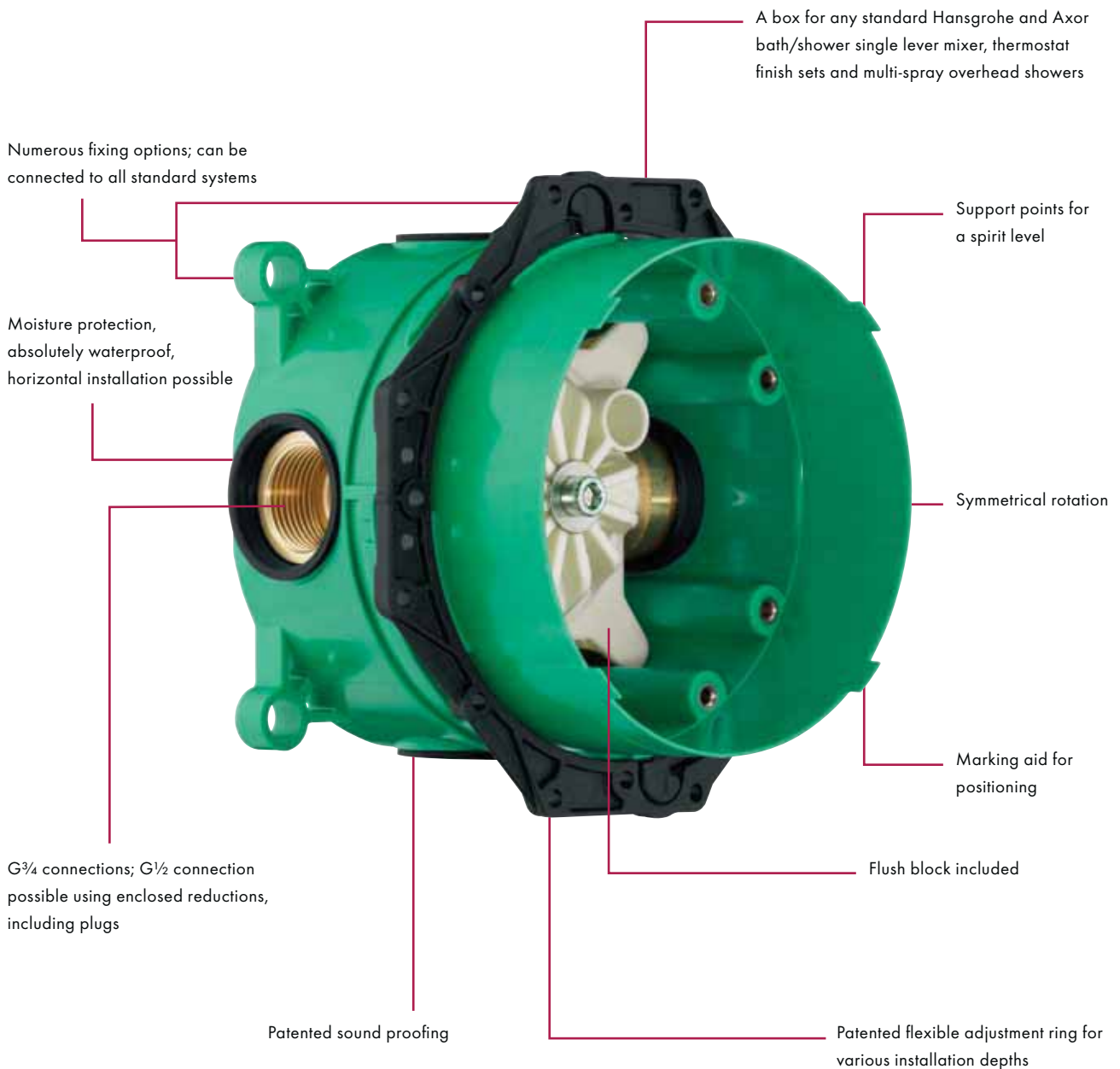

The many advantages of the iBox® universal

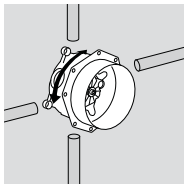

Rotationally symmetrical installation

- Symmetrical structure; all connections are equal.
- It is important that the cold water is connected on the right and the hot water on the left.
- When used as a bath mixer, the lower outflow takes priority.
- When the iBox universal is used as a shower mixer, either the upper or lower outflow can be connected.

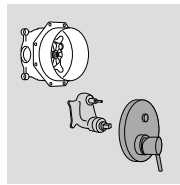

Safe and economical

- The basic set contains just the connection block.
- The valuable fitting aid is delivered and installed later, together with the finish set.
- Prevents problems like theft, dirt and frost damage occurring during the building phase and expensive warehousing becomes unnecessary.

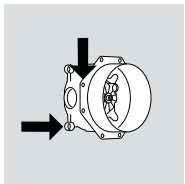

Multiple installation options

- Coordinated with all current installation systems and all types of connections and fittings.
- Patented flexible adjustment ring.
- Mounting options at two levels and G $\frac{3}{4}$ connections for universal installation possibilities.
- Also suitable for thicker walls and dry wall installations as well as for pre-fabricated housing systems.

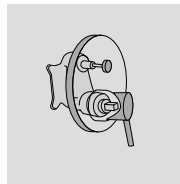

Integrated safety combination

- When installing a concealed single lever bath mixer with integrated safety combination – together with an Exafill bath filler with waste and overflow set – a non return valve becomes unnecessary. This reduces installation costs as well as the number of functional parts inside the wall.

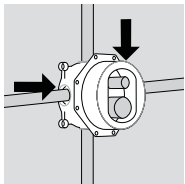

Excellent protection against humidity

- This will protect against splashing water and moisture coming from any direction.
- Seals on all four connections and the supporting collar.

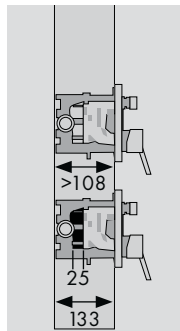

Solutions for walls that are either very deep or very shallow

- If the iBox universal sits too deep in the wall, the basic unit extension is fitted between the connector and the function block.
- The extension set ensures safety right up to the wall and keeps the walls free from dampness.
- The iBox universal standard basic set has been made flatter and is now even better suited for walls with limited installation depths.

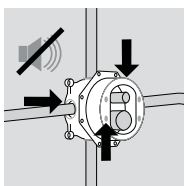

Low noise level

- The brass body rests on seals, preventing sound from the water-conducting parts from being transferred through the wall.
- The supporting collar is screwed to the iBox universal housing and not to the function block, which prevents sound from being transferred through to the tiles.

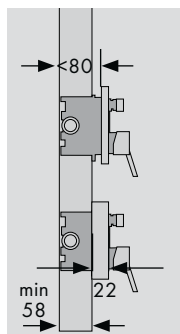

Collar extension

- Thanks to the extension, even limited installation depths are no longer a problem.
- The extension collar makes it possible to install the iBox universal despite the lack of depth.

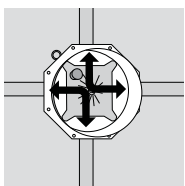

Easy rinsing

- The rinse block supplied with the iBox universal can be mounted in different positions. This makes it easy to flush the pipes through to where they finish at the wall.

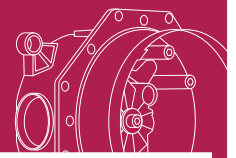

iBox® universal
Strengths and benefits

Flexibility that benefits everyone

Sine the launch in 2001, Hansgrohe's iBox universal has been setting standards in the bathroom. As a veritable all-rounder, it is designed to go with any standard installation system, connection and fitting. It also offers unique advantages that benefit you, whether you are a retailer, installer or wholesaler for project business.

How you as a retailer benefit from the iBox® universal:

- You only need one basic set for 16 function solutions
- Over 200 Hansgrohe and Axor finish sets fit on the iBox universal
- You only have to keep one basic set in stock, which reduces storage space and costs
- The iBox universal fits on lots of installation systems, connection items and fittings
- Durability guaranteed by a tried-and-tested, safe technical standard
- You save time, because the iBox universal is quickly and easily installed
- The iBox is an innovative success factor: proven and consistently developed for over 12 years

How you benefit from the iBox® universal in your project business:

- The iBox universal offers a high level of flexibility and allows a variety of design options
- Your project planning will be much easier: one base unit will serve for any solution – leaving you with more time to choose the mixer
- The iBox is suitable for use in private or public facilities, and complies with all the main international standards
- Covers any consumer solution with up to 4 functions
- A concealed system that you can rely on – which has been proven millions of times over

How the iBox® universal benefits consumers:

- More time to choose the mixers
- An attractive bathroom, as all the technology hidden behind the wall
- Greater freedom of movement when showering
- Easy to replace with new mixers when renovating
- The safety of a solution that has been proven for over 12 years

The optimum foundation for the new Select technology

The ShowerSelect finish sets for the iBox universal can be used to offer the innovative Select technology, which the consumer controls at the touch of a button. The Select technology delights customers with its design and revolutionary control concept. The focus is on the Select button. A simple touch of a button is all it takes to switch functions on and off or change the spray types. Everything works purely mechanically, which provides long-lasting reliability – and thus permanently satisfied customers.

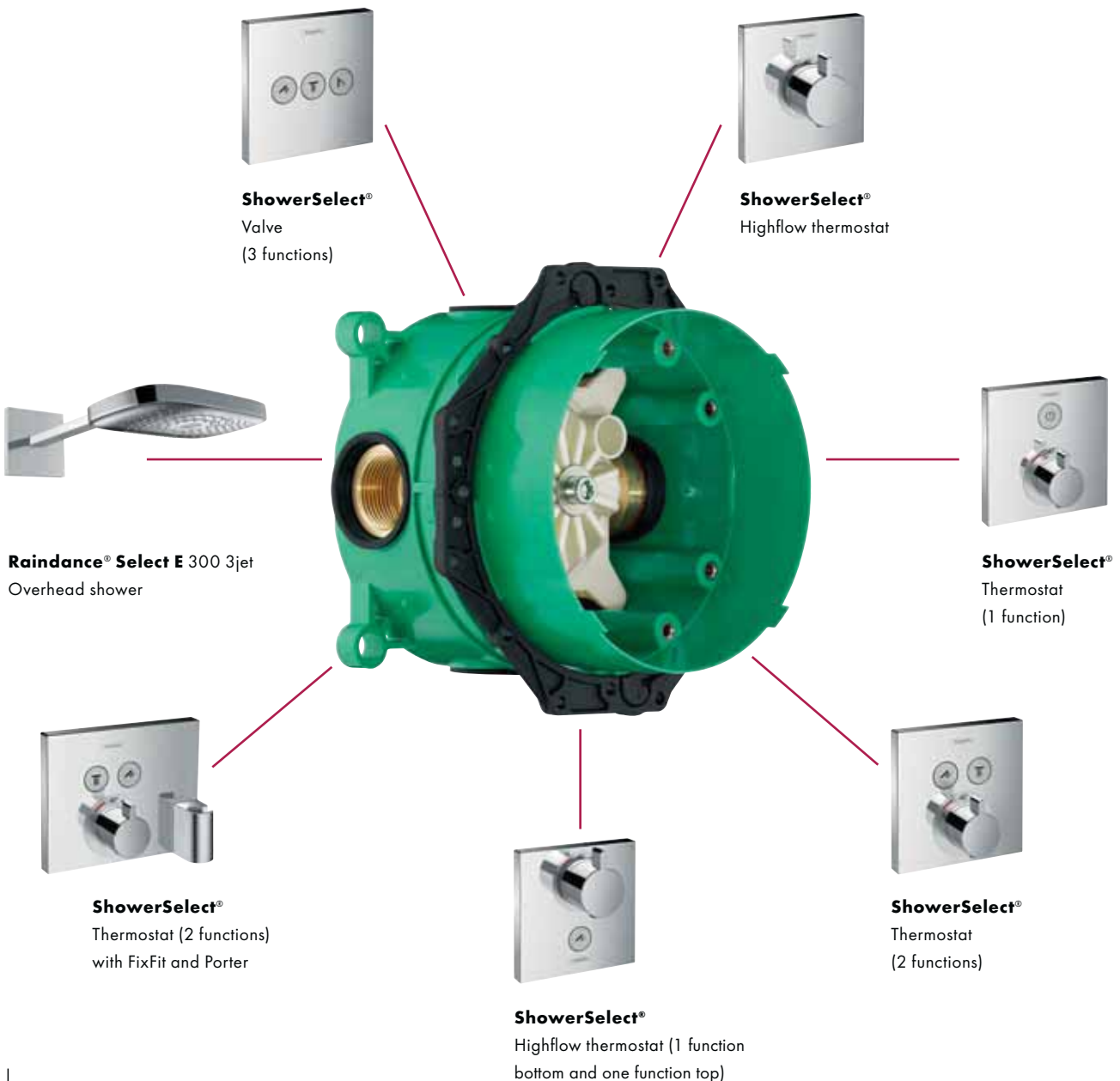

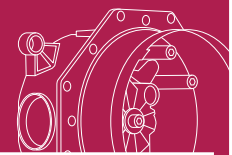

iBox® universal
ShowerSelect® design

ShowerSelect® finish sets: design where everything fits

A geometric shape that blends perfectly with the modern bathroom. Buttons that integrate flush in the overall picture and a control concept that harmonises with the desire for shower pleasure. The new, smart ShowerSelect finish sets appeal for a design that is visually and functionally perfect. So it's practically made for you to help you acquire new customers.

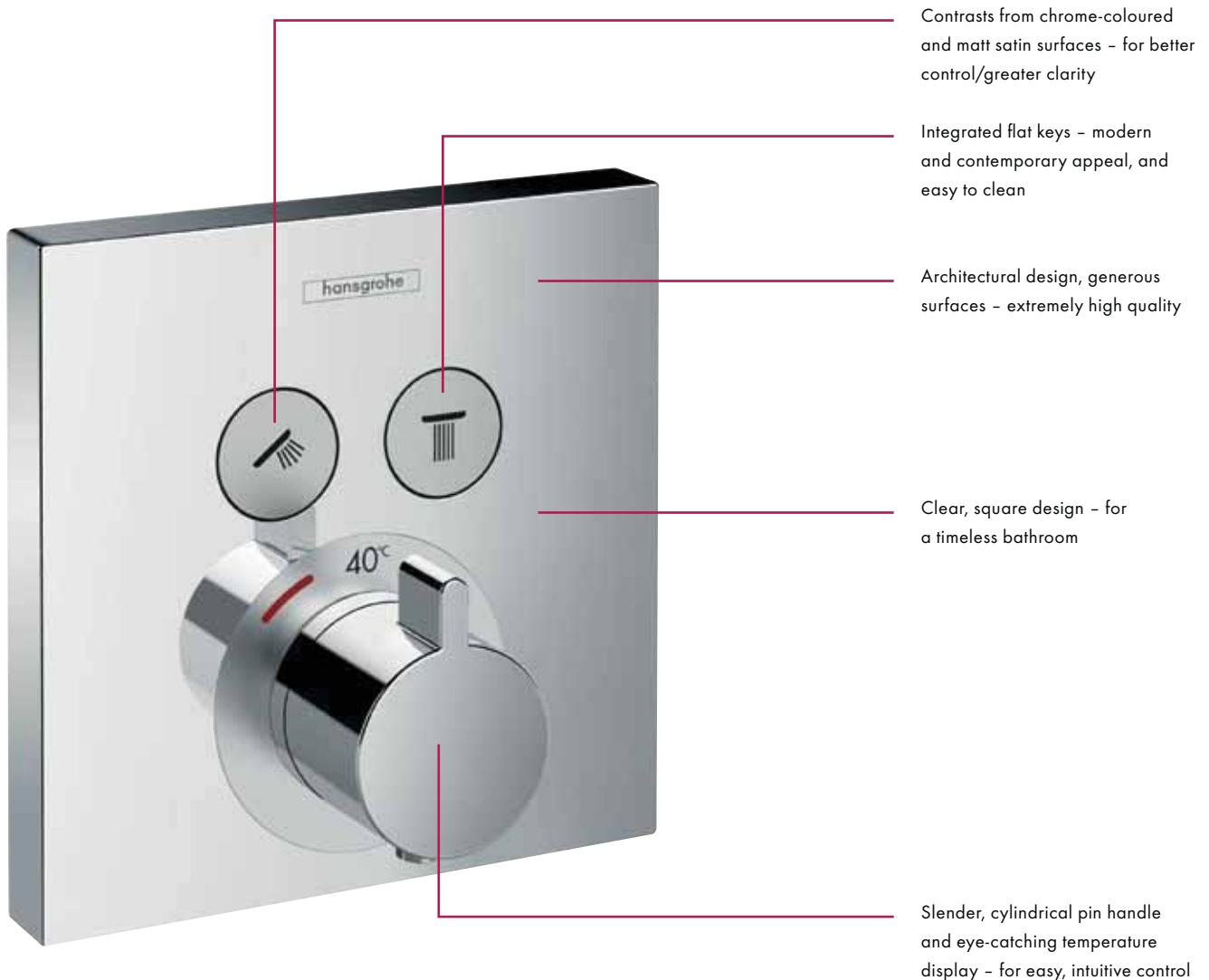

DESIGN PLUS

powered by: **ISH**



Award-winning design

The ShowerSelect finish set with its aesthetic appeal and user friendliness was awarded the "Design Plus Award" by the Design Council. The ShowerSelect finish set for 2 functions received the "Bathroom comfort for generations" product award of the ZVSHK, the German Central Association Plumbing, Heating and Air Conditioning, for excellent design for users with restricted mobility.

iBox[®] universal and ShowerSelect[®]: the new way to control shower pleasure

Form and function go hand in hand with the new ShowerSelect finish sets. From easy-to-use control elements and intuitive handling to easy cleaning: with their many advantages, the ShowerSelect finish sets are perfect for selecting your shower pleasure. Delight your customers with the many advantages of the ShowerSelect finish sets.



Intuitive:

The Select buttons for intuitive, comfortable control – even for elderly and less able customers.



Clear:

Easy-to-understand symbols that do not rub off simplify operation even further, and are extremely durable.



Easy to use:

The protruding button instantly reveals the active functions. Can be controlled using an elbow or fist thanks to the button extension that is included in the box.



User-friendly:

The desired temperature can be set precisely with the user-friendly handle.



Clean:

The flush-fit buttons leave a flat surface that is easy to clean.



Attractive:

The modern rectangular shape blends perfectly with a tiled bathroom.



Economical:

The easy push-button encourages the user to switch the water off frequently, which helps to save water.



Luxurious:

The functions can all be set at the same time – for even greater shower pleasure.

ShowerSelect® – Advantages at the touch of a button

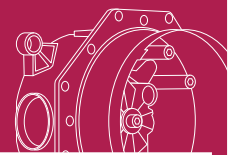

iBox® universal
ShowerSelect® advantages

How you as a retailer benefit from the ShowerSelect® finish sets:

- New, unique products on the market in an attractive and exclusive design
- Additional sales opportunities through the acquisition of new customers
- Complete collection for broad range of applications
- Universal combinations with any Raindance or Raindance Select shower and competitor products
- Easy to install on the well-known concealed iBox universal system, tried and tested since 2001
- High potential in renovations
- Long-lasting thanks to mechanical valves, which means permanently satisfied customers and no complaints
- Direct use possible, as all the required button combinations are included in the box
- Easier installation on 4-function solution

How you benefit from the ShowerSelect® finish sets in your project business:

- New architectural design in the Hansgrohe concealed range
- Clear, reduced, minimalistic and precise style – for timeless bathroom design
- Attractive price segment
- Safe, easy planning, since all the applications are covered by 1 to 4 functions
- Also suitable for semi-public areas, as thermal disinfection is easily possible

How consumers benefit from the ShowerSelect® finish sets:

- Geometric-square design, making it suitable for any bathroom and lots of tile types
- Intuitive, easy control at the touch of a button
- Large symbols – for easy handling and clarity
- Safe, visible temperature adjustment thanks to the slender, cylindrical pin handle and eye-catching coloured temperature display
- Fast, inexpensive renovations possible by simply replacing the existing finish sets
- Easy to clean thanks to flush-fit buttons
- Easy to push button helps to save water by encouraging the user to push it
- High level of comfort by simultaneously setting several functions

The ShowerSelect® finish set range



ShowerSelect®
Thermostat
for 1 function
15762, -000

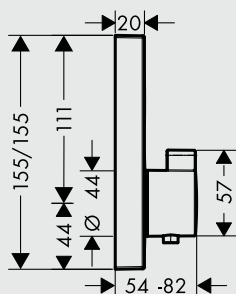

All flow rates without functions.

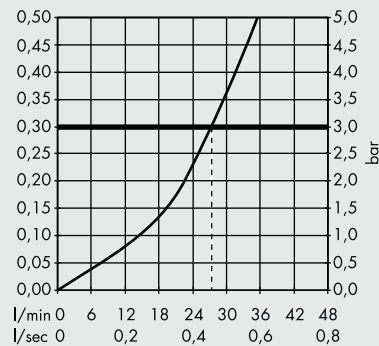

ShowerSelect®
Thermostat
for 2 functions
15763, -000

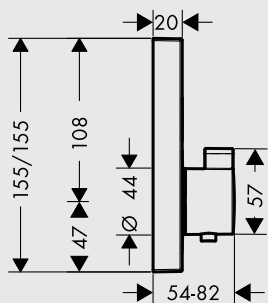

All flow rates without functions.

Legend

- ① bottom
- ② top

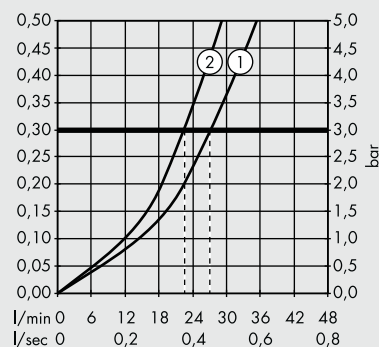

ShowerSelect®
Thermostat
for 2 functions
with FixFit and Porter
15765, -000

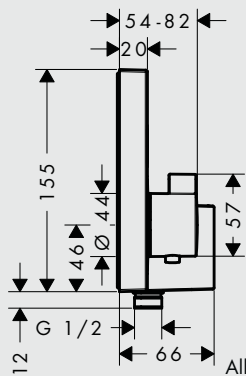

All flow rates without functions.

Legend

- ① bottom
- ② top

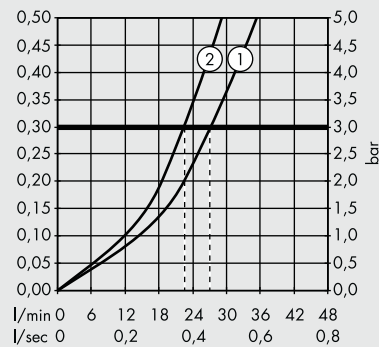

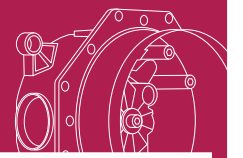

iBox® universal
The ShowerSelect®
finish set range



ShowerSelect®
Valve
for 3 functions
15764, -000

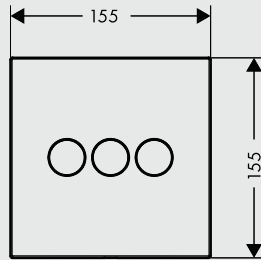

Legend

- ① left
- ② top
- ③ right

All flow rates without functions.

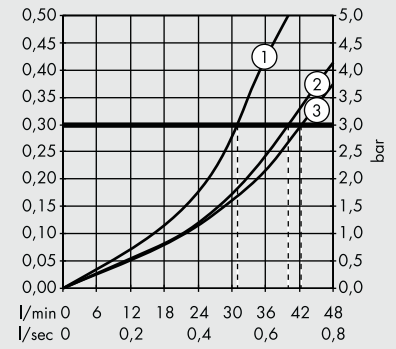

ShowerSelect®
Highflow thermostat
15760, -000

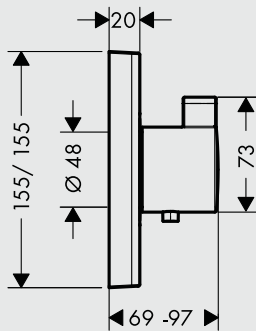

All flow rates without functions.

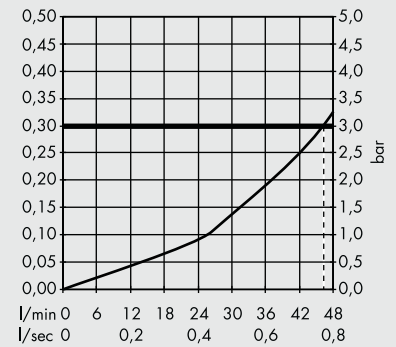

ShowerSelect®
Highflow thermostat
for 1 function (bottom) and one
additional function (top)
15761, -000

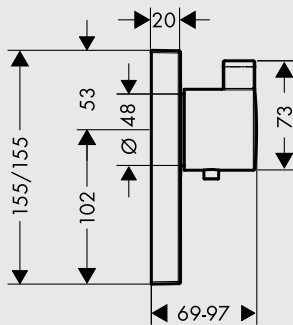

All flow rates without functions.

Legend

- ① bottom
- ② top

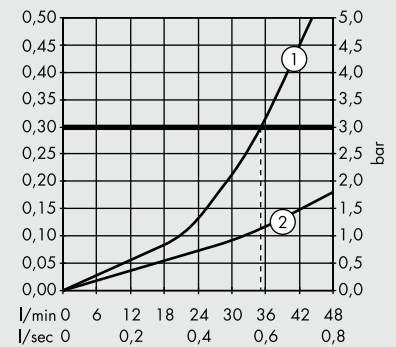

Possible uses for 1 to 4 functions

Shower system with 1 function

For instance, overhead **or** hand shower



ShowerSelect thermostat for 1 function

Shower system with 2 functions

For instance, overhead **and** hand shower



ShowerSelect thermostat for 2 functions

Other possible installations



Thermostat with shut-off valve

Other possible installations



Thermostat with shut-off/diverter valve



Single lever shower mixer



Single lever mixer with diverter



iBox® universal

Examples of uses for
1 to 4 functions

Shower system with 3 functions

For instance, overhead shower (2 spray types) **and** hand shower



ShowerSelect valve
for 3 functions



ShowerSelect Highflow thermostat

Shower system with 4 functions

For instance, overhead shower (3 spray types) **and** hand shower



ShowerSelect valve
for 3 functions



ShowerSelect Highflow thermostat
for 1 function (bottom) and one
additional function (top)

Other possible installations



iControl shut-off/diverter valve



Highflow thermostat

Other possible installations



Trio/Quattro
shut-off/diverter
valve



Shut-off valve



Highflow
thermostat



Shut-off valve



iControl
shut-off/diverter
valve



Highflow
thermostat



Shut-off valve

Installation 1 function

Ceiling 

Flow diagram

Hand shower Raindance S 120 3jet
26530000

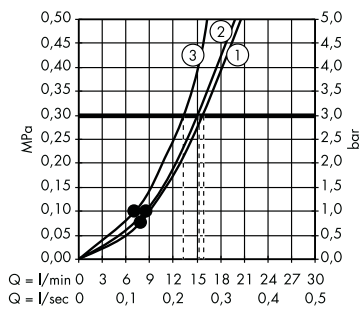

Minimum operating pressure •

Components

Mixers

- Ⓑ iBox universal
01800180
ShowerSelect thermostat
15762000



Alternative:
Metris thermostat
31572000

Other alternatives possible.

Showers

- Ⓐ Raindance Select S 120
26530000
Shower holder Porter S
28331000
Shower hose Isiflex
28276000
- Ⓒ Hose connection FixFit
27453000
- Ⓓ Waste system Staro 90
60056000

- Legend**
- Ⓐ RainAir
 - Ⓑ Rain
 - Ⓒ Whirl

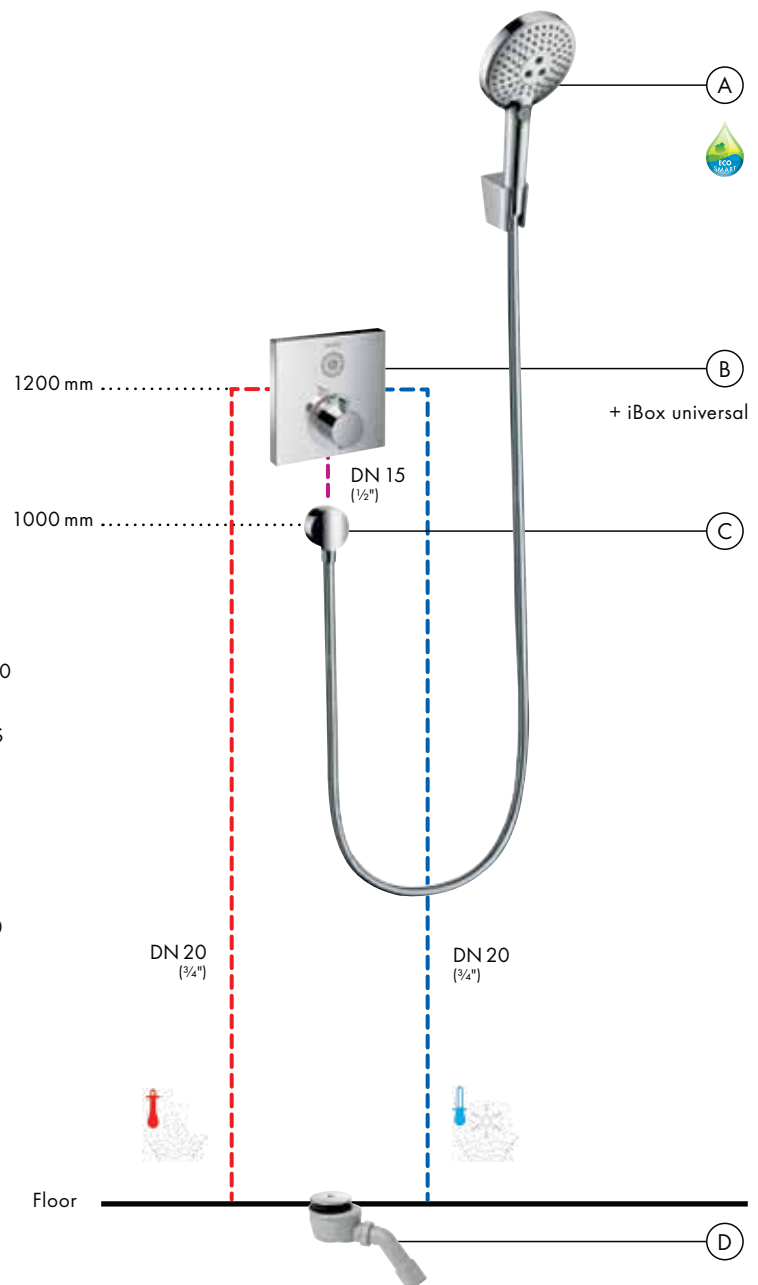

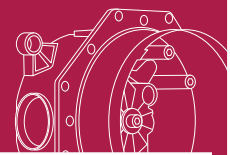

iBox® universal
Installation variant
1 and 2 functions

Installation 2 functions

Flow diagram

Overhead shower Raindance Select S 300 2jet
27378000

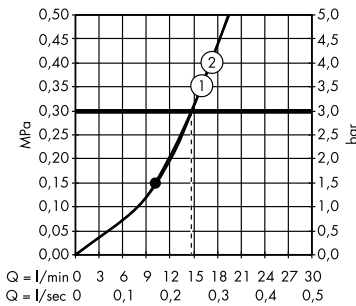

Legend

- ① Rain
- ② RainAir

Flow diagram

Hand shower Raindance S 120 3jet
26530000

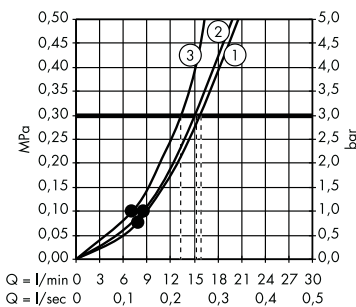

Legend

- ① RainAir
- ② Rain
- ③ Whirl

Minimum operating pressure •

Components

Mixers

- Ⓑ iBox universal
01800180
ShowerSelect thermostat
15763000



Alternative:
Metris thermostat
with shut-off/diverter valve
31573000

Other alternatives possible.

Showers

- Ⓐ Raindance Select S 300 2jet
Overhead shower
27378000
- Ⓒ Raindance Select S 120
Hand shower
26530000
Shower holder Porter S
28331000
Shower hose Isiflex
28276000
- Ⓓ Hose connection FixFit
27453000
- Ⓔ Waste system Staro 90
60056000

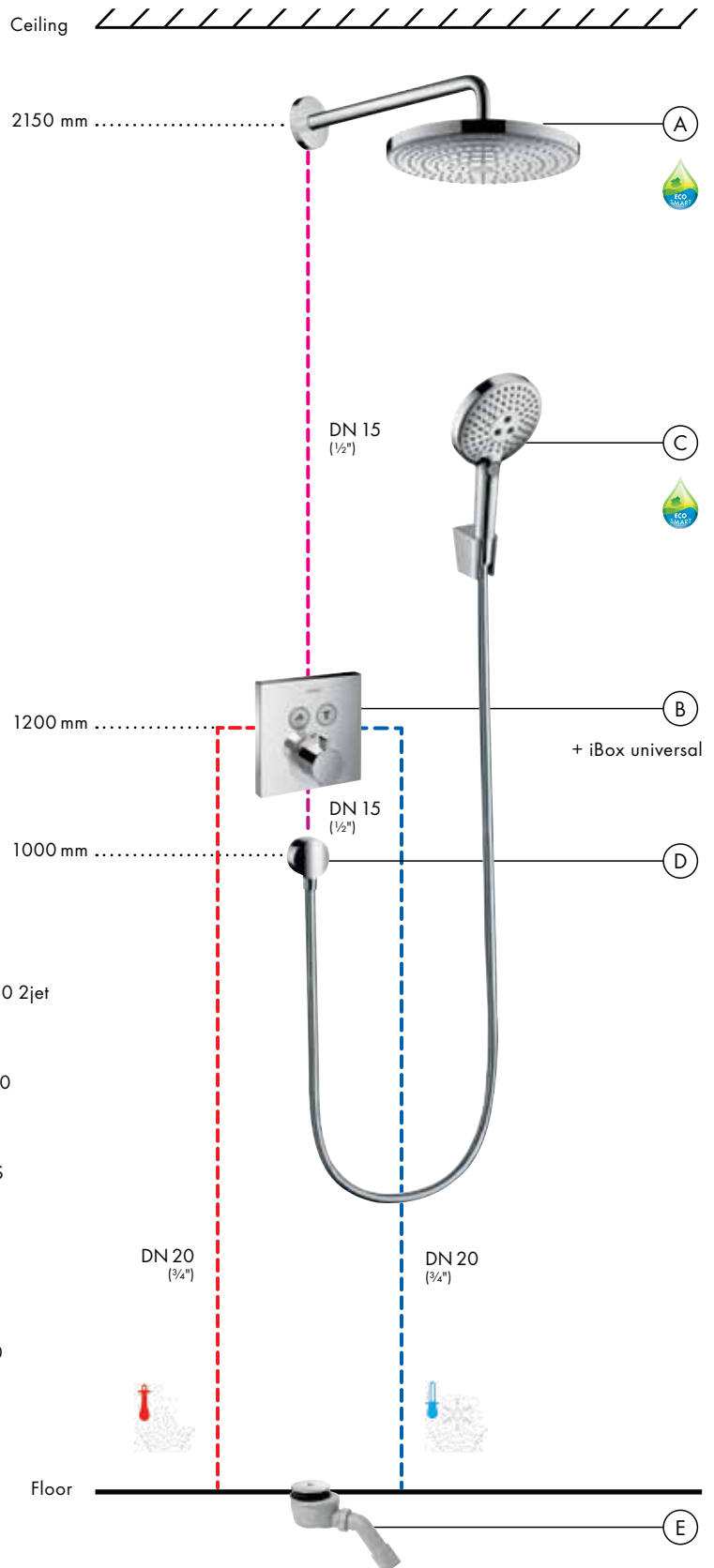

Installation 3 functions: Select

Flow diagram

Overhead shower Raindance Rainfall 2jet
#28433000

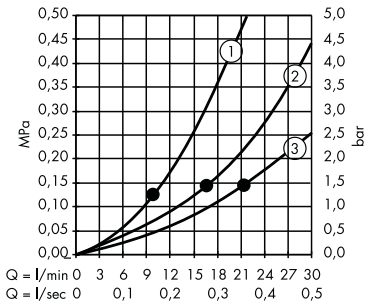

Legend

- ① RainAir
- ② Rainflow
- ③ RainAir + Rainflow

Flow diagram

Hand shower Raindance S 120 3jet
#26530000

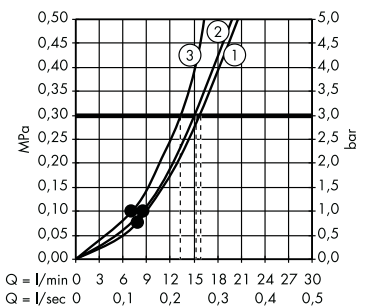

Legend

- ① RainAir
- ② Rain
- ③ Whirl

Minimum operating pressure •

Components

Mixer installation

- Ⓒ iBox universal
#01800180
ShowerSelect valve for
3 functions
#15764000
- Ⓓ iBox universal
#01800180
ShowerSelect thermostat
#15760000

Shower installation

- Ⓐ Raindance Rainfall 2jet
#28433000
iBox universal
#01800180
- Ⓑ Raindance Select S 120
Hand shower
#26530000
Shower holder Porter S
#28331000
Shower hose Isiflex
#28276000
- Ⓔ Hose connection FixFit
#27453000
- Ⓕ Waste system Raindrain XXL
#60067000

- Alternative:
- Metris iControl
#31958000
- Metris Highflow thermostat
#31571000

Other alternatives possible.

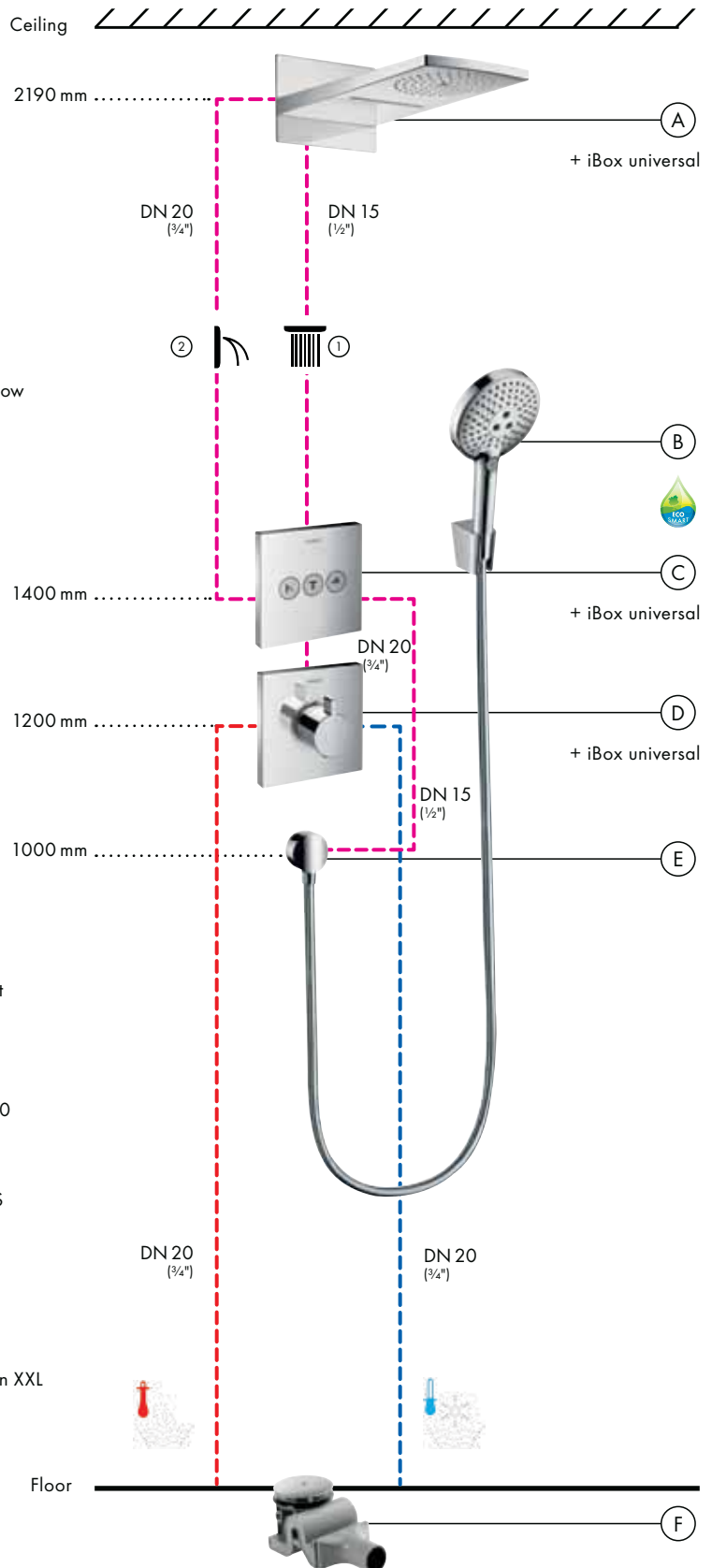

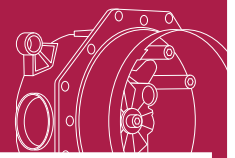

iBox® universal
Installation variant
3 functions

Installation 3 functions: Standard

Flow diagram

Overhead shower Raindance Rainfall 2jet
28433000

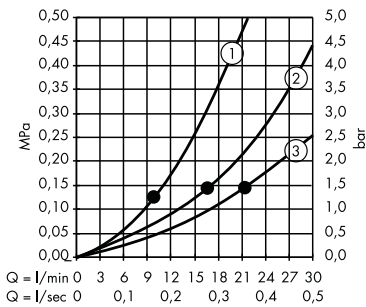

Legend

- ① RainAir
- ② Rainflow
- ③ RainAir + Rainflow

Flow diagram

Hand shower Raindance S 120 3jet
26530000

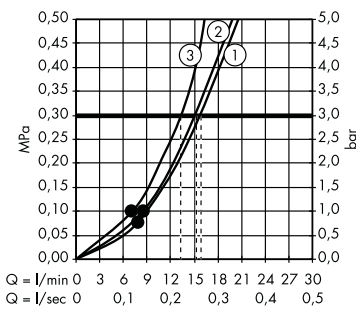

Legend

- ① RainAir
- ② Rain
- ③ Whirl

Minimum operating pressure •

Components

Mixer installation

- Ⓒ Basic set Trio/Quattro
15981180
Shut-off valve Trio/Quattro S
15932000
- Ⓓ iBox universal
01800180
Ecostat S Highflow thermostat
15715000
- Ⓔ Basic set shut-off valve
15974180
Shut-off valve S DN15/DN20
15972000

Shower installation

- Ⓐ Raindance Rainfall 2jet
28433000
iBox universal
01800180
- Ⓑ Raindance Select S 120 3jet
Hand shower
26530000
Shower holder Porter S
28331000
Shower hose Isiflex
28276000
- Ⓕ Hose connection FixFit
27453000
- Ⓖ Waste system Raindrain XXL
60067000

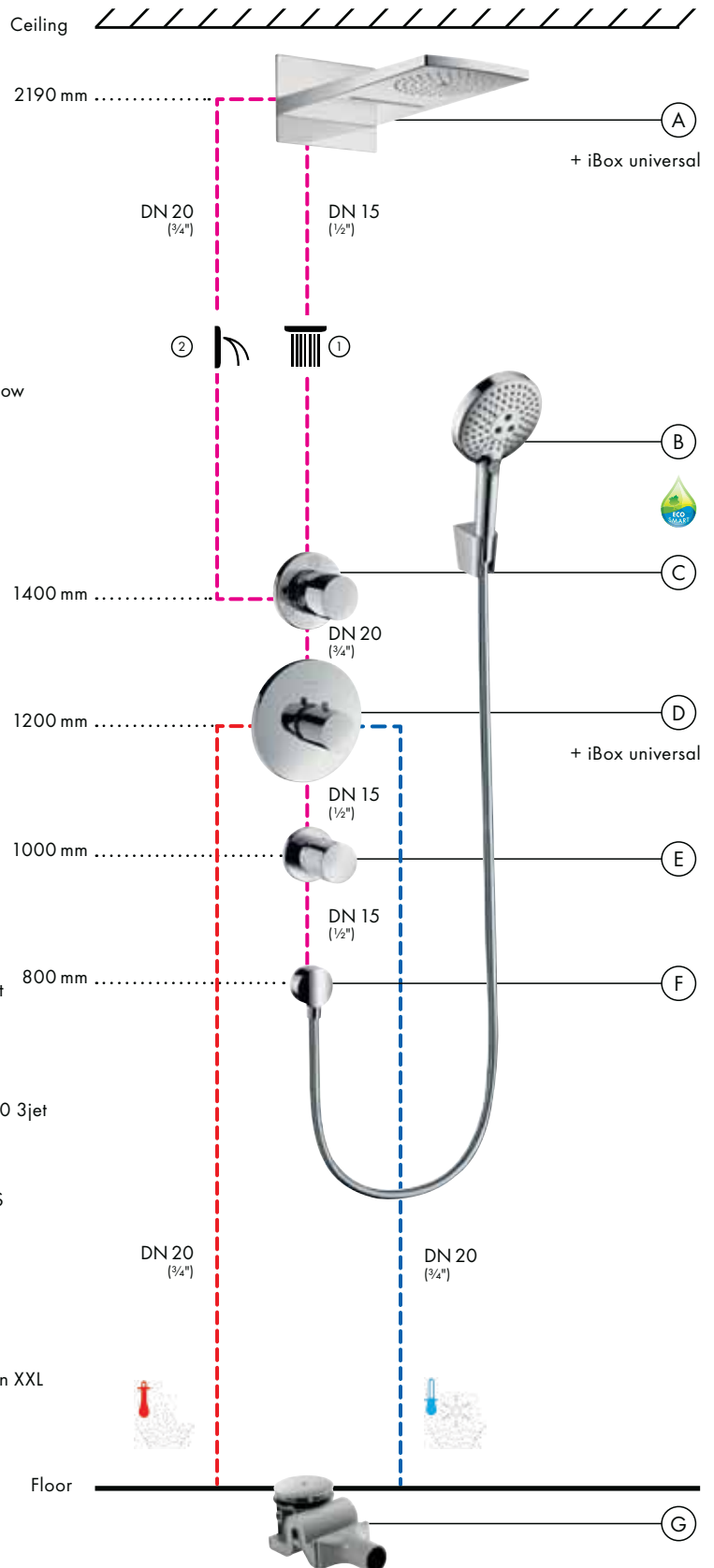

Installation 4 functions: Select

Flow diagram

Overhead shower Raindance Rainfall 3jet
28411000

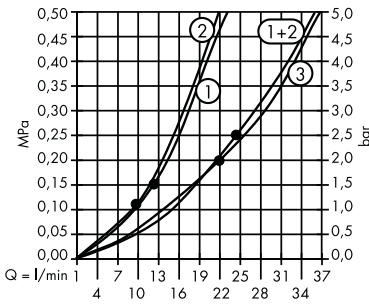

Legend

- ① Rain
- ② Whirl
- ③ RainAir

Flow diagram

Hand shower Raindance S 120 3jet
26530000

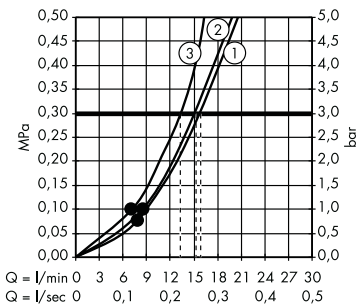

Legend

- ① RainAir
- ② Rain
- ③ Whirl

Minimum operating pressure •

Components

Mixer installation

- Ⓒ iBox universal
01800180
ShowerSelect valve for
3 functions
15764000
- Ⓓ iBox universal
01800180
ShowerSelect thermostat
15761000

Shower installation

- Ⓐ Raindance Rainfall 3jet
28411000
iBox universal
01800180
- Ⓑ Raindance Select S 120
Hand shower
26530000
Shower holder Porter S
28331000
Shower hose Isiflex
28276000
- Ⓔ Hose connection FixFit
27453000
- Ⓕ Waste system Raindrain XXL
60067000

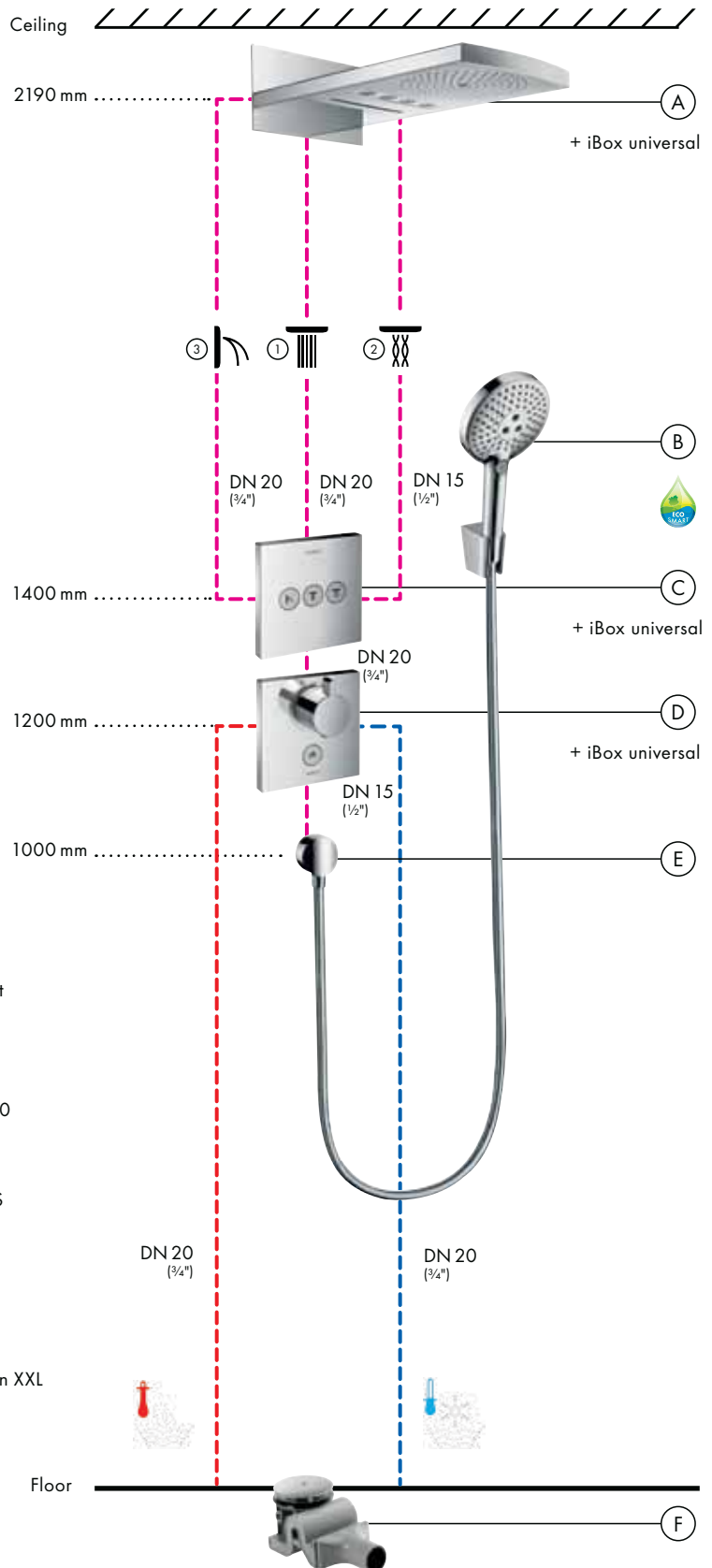

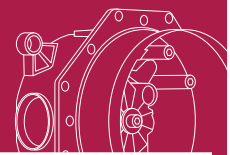

iBox® universal
Installation variant
4 functions

Installation 4 functions: Standard

Flow diagram

Overhead shower Raindance Rainfall 3jet
28411000

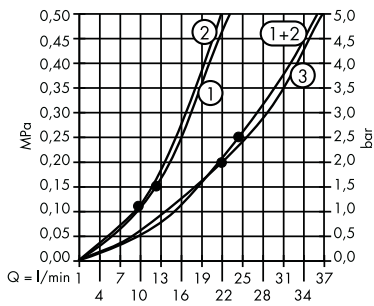

Legend

- ① RainAir
- ② Whirl
- ③ Rainflow

Flow diagram

Hand shower Raindance S 120 3jet
26530000

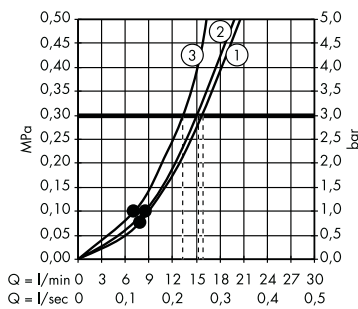

Legend

- ① RainAir
- ② Rain
- ③ Whirl

Minimum operating pressure •

Components

Mixer installation

- Ⓒ Basic set Quattro
15930180
Shut-off valve Trio/Quattro S
15932000
- Ⓓ Basic set shut-off valve
15970180
Shut-off valve S DN15/DN20
15972000
- Ⓔ iBox universal
01800180
Ecostat S thermostat
15715000
- Ⓕ Basic set shut-off valve
15974180
Shut-off valve S DN15/DN20
15972000

Shower installation

- Ⓐ Raindance Rainfall 3jet
28411000
iBox universal
01800180
- Ⓑ Raindance Select S 120 3jet
Hand shower
26530000
Shower holder Porter S
28331000
Shower hose Isiflex
28276000
- Ⓖ Hose connection FixFit
27453000
- Ⓗ Waste system Raindrain XXL
60067000

Other alternatives possible.

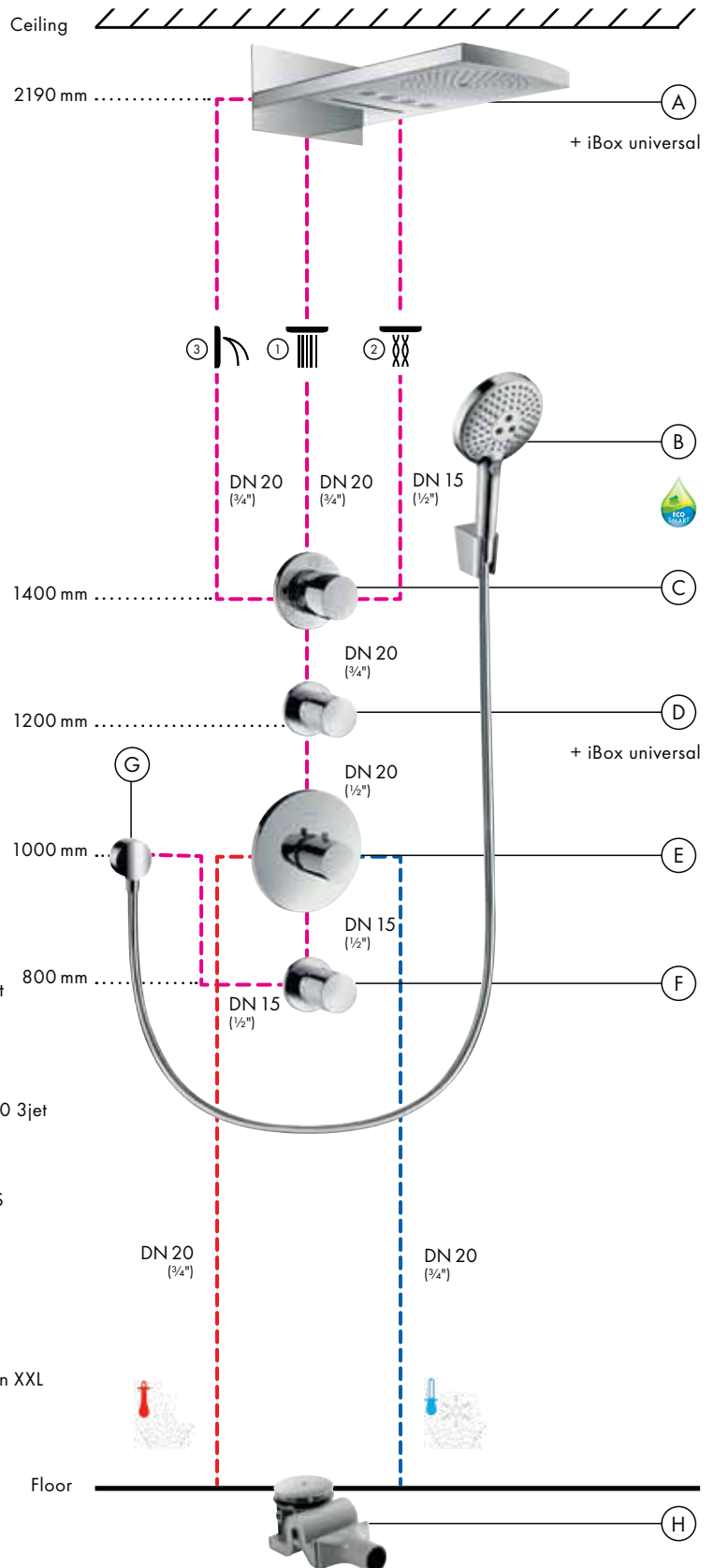

iBox® universal installation

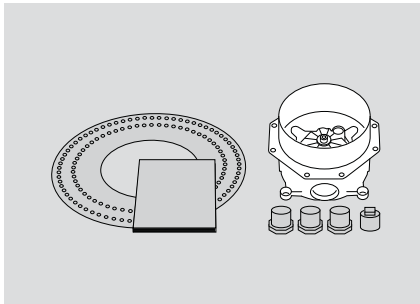

All you need – iBox universal plus sealing cuff, 3 reduction nipples from DN20 to DN15, 1 plug DN20, flush block, building protection cap, 1 plug for raw installation Exafill bath filler (with waste system), installation instructions. No need to order additional accessories.

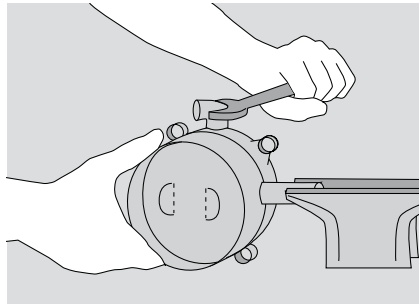

Installation tip – to turn in connection, secure the iBox universal in the vice using a piece of pipe with a G $\frac{3}{4}$ thread.

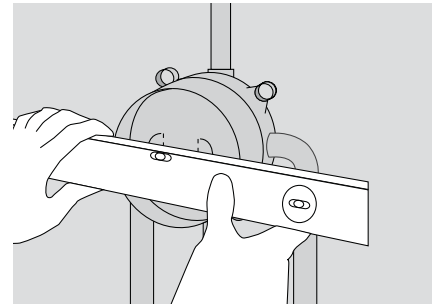

In the right position – it's easy to level out the iBox universal using the attached positioning tools.

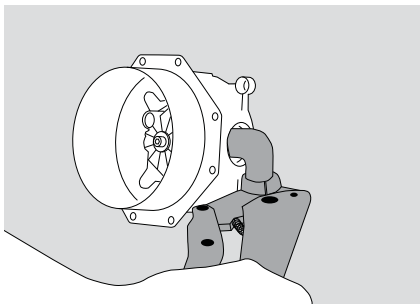

Right connections – designed to match any standard pipe system, the fittings can be pressed directly against the iBox universal.

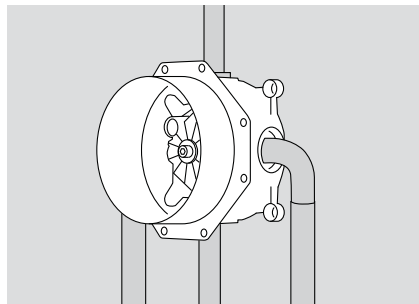

Matching any standard installation systems – thanks to the 2 fixing levels and the many different fixing options, the iBox universal will fit on any standard installation system.

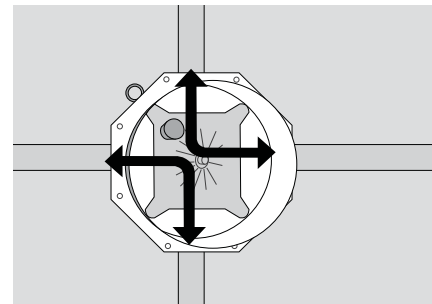

Standard flushing to DIN 1988 – thanks to the flush block that is included, it is possible to flush the pipes in any targeted direction.

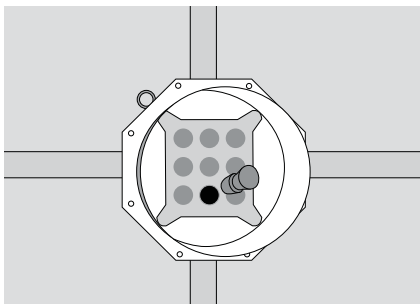

Plug for Exafill outlet – this plug ensures that, after testing the pipe system and filling the bath, the pressure in the whole pipe system is maintained even after the water to the intake is switched off.



127 mm drill – the circular shape of the iBox universal was deliberately chosen so a drill can be used. This makes it easy to make cut-outs in the wall-covering or tiles.

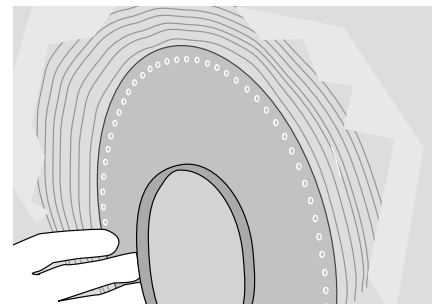

Sealing cuff for wall front installation – to ensure there are no leaks with wall front installation, the sealing cuff is pushed into PCI Lastagumon on the wall (or similar sealant that complies with the manufacturer's information).

ShowerSelect® finish set installation

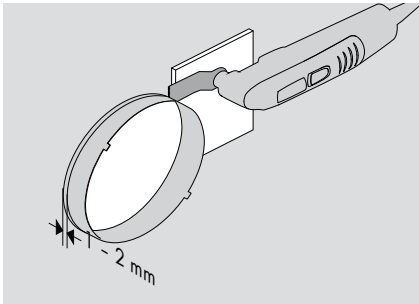

Leave 1-2 mm free – the protruding rim of the iBox universal is trimmed away with a sharp cutter or similar tool approx. 2 mm from the tiles. Protect the tiles. Seal with silicon.

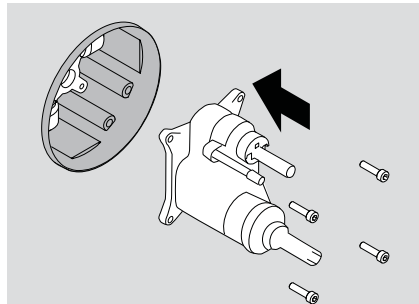

Installation functions block – first remove the flush block. Then insert the ShowerSelect functions block and secure using the enclosed fixing materials at a tightening torque of 5 Nm.

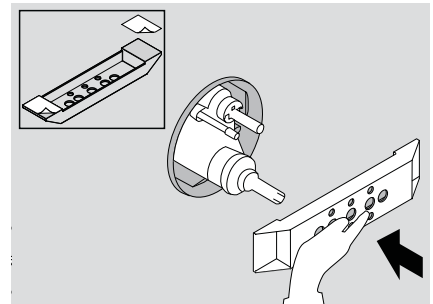

Enclosed template – the template with corresponding holes is used as an aid to shortening the button extension.

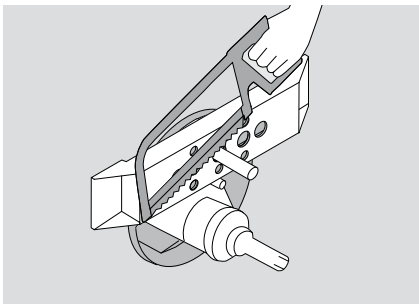

Shorten extensions – the button extensions are sawn flush at template height. Smooth any irregularities with sandpaper to leave a level surface.

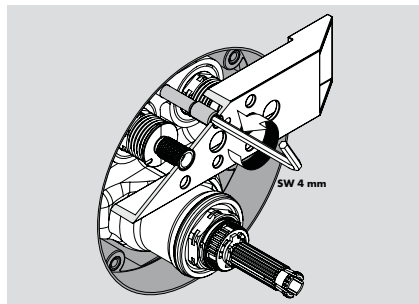

Adjust the centring screw – use a 4 mm Allen key (SW 4 mm) to undo the screw as far as the inner edge of the template.

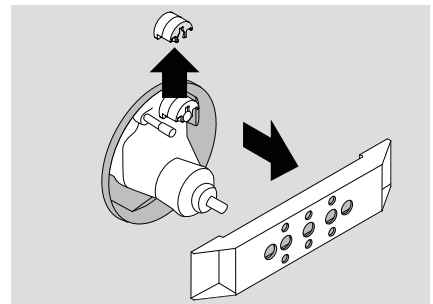

Remove spring attachment – remove the template and pull the spring attachment upwards.

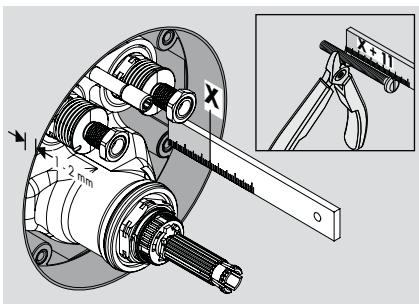

Measure precisely – use a folding rule or tape measure to measure the length for the fixing screws of the carrier escutcheon. Use pliers to shorten the plastic screws to the calculated length.

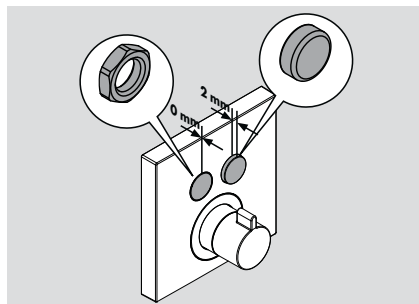

Define key position – Flush-fit installation (0 mm), raised (2 mm) with the extension cap using the enclosed nut.

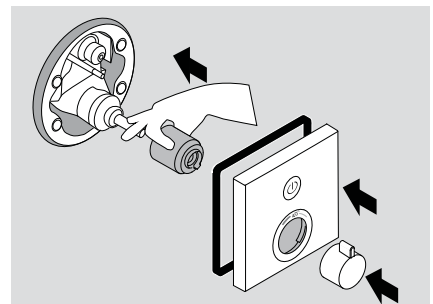

Install finish set – tighten the carrier escutcheon and slide the cartridge sleeve into place. Then put the foam rubber seal in the escutcheon. Attach escutcheon and seal to the carrier escutcheon together. Clip thermostat handle into place.

Select button installation extension

Extension caps are used to extend the button position by 2 mm. This will make it even easier to use the control elements. Users with limited mobility can use an elbow or fist to operate.

Without extension cap



Select button, without extension cap, closed and flush-fit



Select button, without extension cap, open, 4 mm

With extension cap



Select button, with extension cap, closed, 2 mm



Select button, with extension cap, open, 6 mm

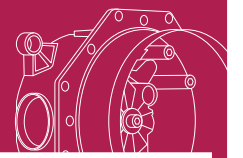

Standard finish set installation

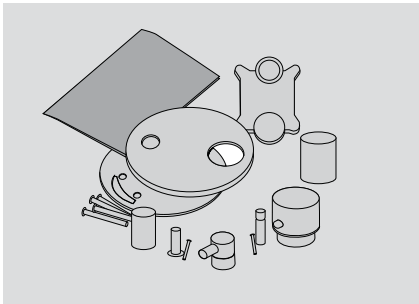

iBox® universal – all ready for bathing fun: functions block, fixing screws, escutcheon, handle sleeves, handle adapter, handles and installation instructions.

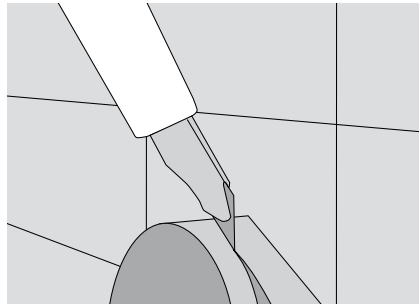

28 mm tile leveller – after tiling, the protruding rim of the iBox universal is trimmed with a knife to 2 mm in front of the tiles. This ensures an absolutely leakproof fit.

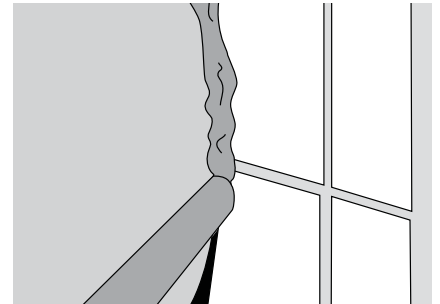

Seal with silicon – to ensure that the unit is sealed against splashes, silicone is injected into the seam between the iBox universal and the tiles.

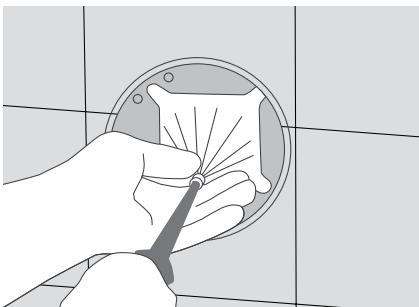

Remove flush block – unscrew the Allen screw and remove the flush block before installing the functions block. Don't forget to turn off the water!



Functions block installation – use the enclosed fixing screws to attach the functions block directly to the connecting block.

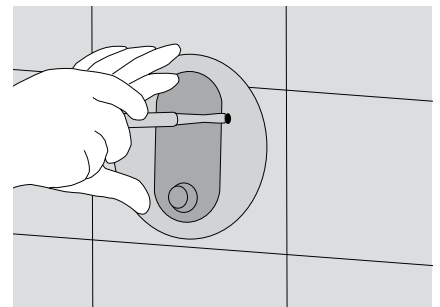

Attach carrier escutcheon – use easy-to-shorten plastic screws to attach the carrier escutcheon to the housing of the iBox universal*. This provides sound-proofing to in front of the tiles. The foam rubber seal will protect against splashes in the area of the join.

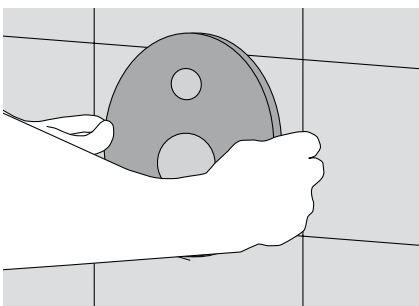

Attach decorative rosette – the screw-free decorative rosette simply slides over the carrier rosette. The protecting foam rubber and O-rings on the openings for the handle sleeves guarantee a safe fit.

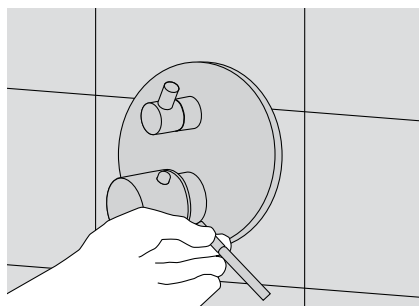

Fixing the handles – finally, snap the handles into place.

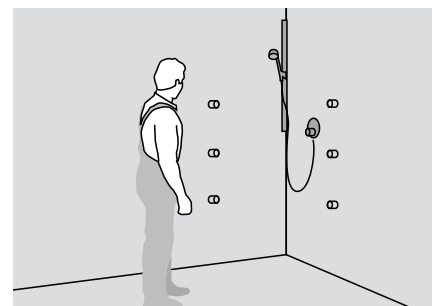

Finish – the iBox universal and desired finish set can be installed in a very short period of time and without having to order any accessories such as stoppers or attachment aids for the various installation methods.

* Do not affix screws using a mechanical or powered screwdriver.

Technical details and dimension drawings

iBox® universal, technical information

Operating pressure:	max. 1 MPa
Recommended operating pressure:	0.1-0.5
Test pressure:	1.6 MPa
(1 MPa = 10 bar = 147 PSI)	
Hot water temperature:	max. 80 °C
Recommended hot water temperature:	65 °C
Connection dimensions:	G 3/4
Connections:	cold right, warm left
Free flow at:	0.3 MPa
Bath mixer outlet bath:	31 l/min
Bath mixer outlet shower:	24 l/min
Single lever shower mixer:	32 l/min
Thermostat:	43 l/min
Thermostat with shut-off valve:	26 l/min
Thermostat with shut-off/diverter valve:	26 l/min
Highflow thermostat:	48 l/min
Test mark:	DVGW, SVGW

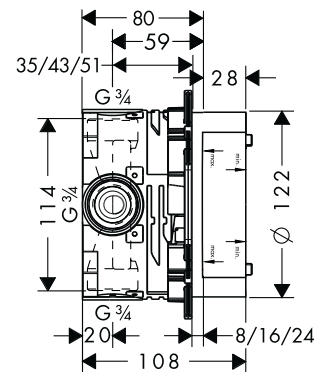
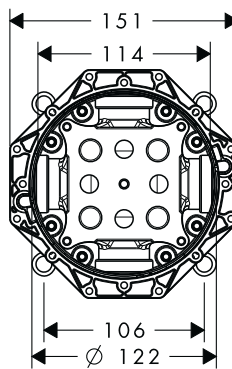

iBox® universal front and side view

iBox® universal

Outlet 2, e.g. shower (top)

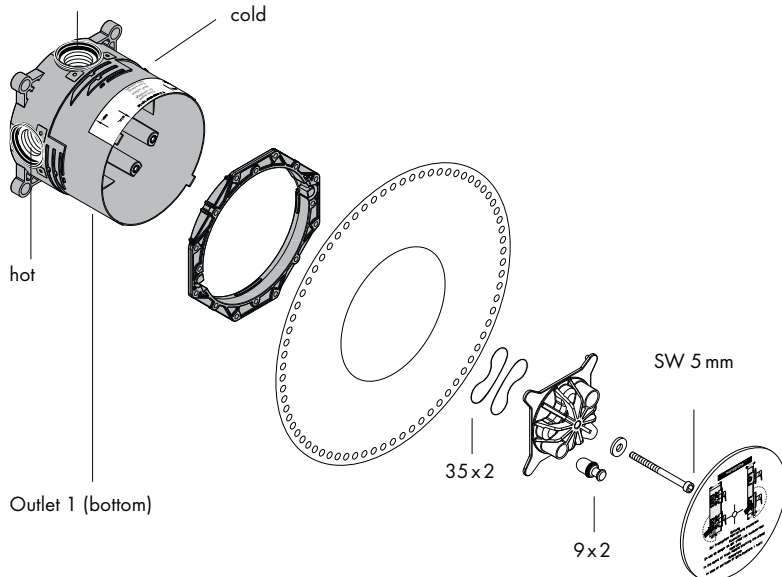

Outlet 1 (bottom)

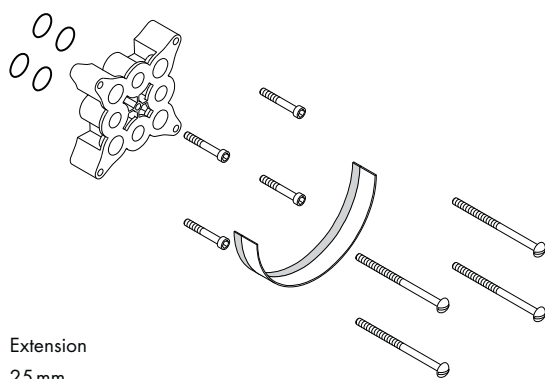

Extension
25 mm



Extension 22 mm (for low installation depth)

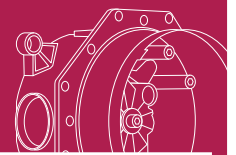

iBox® universal

Technical data

Installation tips

Installation tips and information

Tips for basic installation

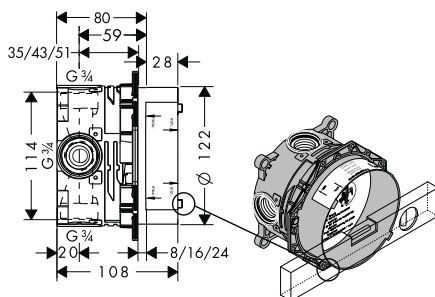
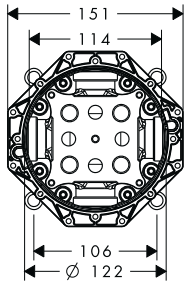

Fit the base unit with the **hot water connection on the left** and the **cold water connection on the right**.

Installation depth 80 to 108 mm.

Extension set 25 mm for too deep installation:

13595000

Extension set 22 mm for too deep installation depths:

13596000 for escutcheons Ø 170 mm

13597000 for escutcheons Ø 150 mm

97407000 for escutcheons Ø 172 mm

15597000 for PuraVida

13593000 for ShowerSelect

The base unit can be fitted in accordance with the structural conditions. The iBox universal is suitable for both bath and shower installation.

With single-lever bath mixers, the lower outlet (outlet 1) has priority. With shower installations, the outlet that is not required needs to be stopped with a plug.

The symmetrical-rotation base unit of the iBox universal can be used horizontally or vertically.

Exception: installation of bath mixers with safety combinations, where only vertical installation is possible.

Sinks

Complete installation as per DIN 1988/EN 1717, part 2 sinks. The arrows on the flush block indicate which inlet is connected to which outlet line, e.g. cold water with outlet 1 and hot water with outlet 2. If only one outlet is required, then the flush block needs to be rotated by 90° after the first flush.

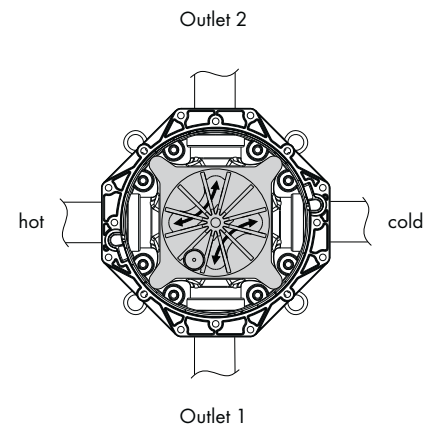

Tips for the bath

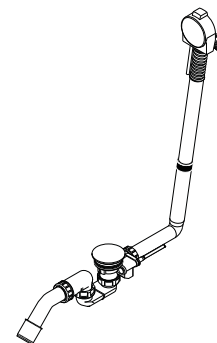
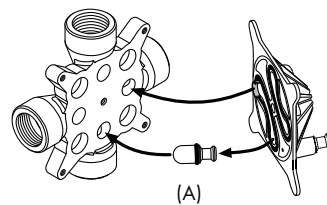

iBox® universal in combination with Exafill bath filler with waste system:

switch off water to the Exafill during the construction stage!

Basic installation:

1. Install iBox universal
2. Lay pipes to Exafill and block (metal plug)
3. Flush and press pipe system

Place bath:





1. Switch off water
2. Install bath with Exafill and connect to mains water
3. Flush pipe to Exafill with sample filler necks and check for leaks
4. Switch off water at floor level
5. Remove flush block
6. Insert plug (A) in outlet for Exafill
7. Fit flush block
8. Switch on water





Go to www.pro.hansgrohe-int.com for the installation instructions.





Product overview Hansgrohe® finish sets

Thermostat/mixer finish sets

ShowerSelect®	ShowerSelect®	ShowerSelect®	ShowerSelect®	ShowerSelect®	ShowerSelect®	
						
Highflow thermostat # 15760,-000	Highflow thermostat for 1 function (bottom) and one additional function (top) # 15761,-000	Valve for 3 functions # 15764,-000	Thermostat for 1 function # 15762,-000	Thermostat for 2 functions # 15763,-000	Thermostat for 2 functions with FixFit and Porter # 15765,-000	

PuraVida®	PuraVida®	PuraVida®	PuraVida®	PuraVida®
				
Thermostat # 15770,-000,-400	Thermostat with shut-off valve # 15775,-000,-400	Shut-off/diverter valve # 15777,-000,-400	Bath # 15445,-000,-400 # 15447,-000,-400*	Shower # 15665,-000,-400
Highflow thermostat # 15772,-000,-400 Not shown	Thermostat with shut-off/diverter valve # 15771,-000,-400 Not shown			

Metris®	Metris®	Metris®	Metris®	Metris®
				
Thermostat # 31570,-000	Thermostat with shut-off valve # 31572,-000	Shut-off/diverter valve # 31958,-000	Bath # 31493,-000 # 31487,-000*	Shower # 31685,-000
Highflow thermostat # 31571,-000 Not shown	Thermostat with shut-off/diverter valve # 31573,-000 Not shown			

Metris® S	Metris® S	Metris® Classic	Metris® Classic	Metris® Classic
				
Bath # 31465,-000 # 31466,-000*	Shower # 31665,-000	Bath # 31485,-000 # 31486,-000*	Shower # 31676,-000	Thermostat with shut-off/diverter valve # 15753,-000

Please refer to the Hansgrohe price list or catalogue for details of the various finishes.

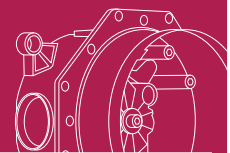

Talis® E²



Bath
31645,-000
31646,-000*

Talis® E²



Shower
31666,-000

Talis®/Talis® S



Bath
32475,-000
32477,-000*

Talis®/Talis® S



Shower
32675,-000

Talis® Classic



Bath
14145,-000
14146,-000*

Talis® Classic



Shower
14165,-000

Focus®



Bath
31945,-000
31946,-000*

Focus®



Shower
31965,-000

Focus® E



Bath
31744,-000

Focus® E



Shower
31761,-000

Focus® S



Bath
31743,-000

Focus® S



Shower
31763,-000

Ecostat® S



Thermostat
15711,-000

Highflow thermostat
15715,-000
Not shown

Ecostat® S



Thermostat
with shut-off valve
15701,-000

Thermostat
with shut-off/diverter
valve
15721,-000
Not shown

iControl® S



Shut-off/diverter valve
15955,-000

Overhead showers/Showerpipe – with iBox® universal basic set

Raindance® Rainfall® 240 Air 3jet



Without light # 28411,-000,-400
With light # 28410,-000,-400

Raindance® Rainfall® 180 Air 2jet



28433,-000,-400

Raindance® Select E 300 3jet



Overhead shower
26468,-000, 400

Raindance® E 420 Air 2jet



Overhead shower
27372,-000

Raindance® 240























Showerpipe
27145,-000

* with integrated safety combination according to EN 1717, part 2.

Product overview Axor® finish sets

Thermostat/mixer finish sets





















Axor® Massaud				Axor® Starck Organic			
							
Thermostat # 18740,-000	Thermostat with shut-off valve # 18745,-000	Bath # 18455,-000 # 18457,-000*	Shower # 18655,-000	Thermostat # 12710,-000	Thermostat with shut-off valve # 12715,-000	Bath # 12415,-000 # 12416,-000*	Shower # 12605,-000
Highflow thermostat # 18741,-000 Not shown	Thermostat with shut-off/diverter valve # 18750,-000 Not shown			Highflow thermostat # 12711,-000 Not shown	Thermostat with shut-off/diverter valve # 12716,-000 Not shown		
Axor® Starck				Axor® Starck X			
							
Thermostat # 10710,-000	Thermostat with shut-off valve # 10700,-000	Bath # 10416,-000 # 10418,-000*	Shower # 10616,-000	Thermostat # 10716,-000	Thermostat with shut-off valve # 10706,-000	Bath # 10445,-000 # 10447,-000*	Shower # 10645,-000
Highflow thermostat # 10715,-000 Not shown	Thermostat with shut-off/diverter valve # 10720,-000 Not shown			Highflow thermostat # 10717,-000 Not shown	Thermostat with shut-off/diverter valve # 10726,-000 Not shown		
Axor® Urquiola							
							
Thermostat # 11730,-000	Thermostat with shut-off valve # 11732,-000	Bath # 11425,-000 # 11426,-000*	Combined bath filler/Porter Unit # 11435,-000	Shower # 11625,-000			
Highflow thermostat # 11731,-000 Not shown	Thermostat with shut-off/diverter valve # 11733,-000 Not shown						

Please refer to the Hansgrohe price list or catalogue for details of the various finishes.



iBox® universal

Select your
Shower Pleasure

Axor® Bouroullec	Axor® Bouroullec	Axor® Bouroullec	Axor® Bouroullec	Axor® Uno²	Axor® Uno²	Axor® Uno²	Axor® Uno²
							
Thermostat # 19700,-000	Thermostat with shut-off valve # 19704,-000	Bath # 19421,-000 # 19422,-000*	Shower # 19621,-000	Thermostat # 38375,-000	Thermostat with shut-off valve # 38700,-000	Bath # 38425,-000 # 38427,-000*	Shower # 38625,-000
Highflow thermostat # 19702,-000 Not shown	Thermostat with shut-off/diverter valve # 19706,-000 Not shown			Highflow thermostat # 38715,-000 Not shown	Thermostat with shut-off/diverter valve # 38720,-000 Not shown		
Axor® Citterio	Axor® Citterio	Axor® Citterio	Axor® Citterio	Axor® Citterio M	Axor® Citterio M	Axor® Citterio M	Axor® Citterio M
							
Thermostat # 39715,-000 # 39710,-000**	Thermostat with shut-off valve # 39705,-000 # 39700,-000**	Bath # 39455,-000 # 39457,-000*	Shower # 39655,-000	Thermostat # 34715,-000	Thermostat with shut-off valve # 34705,-000	Bath # 34425,-000 # 34427,-000*	Shower # 34625,-000
Highflow thermostat # 39716,-000 # 39711,-000** Not shown	Thermostat with shut-off/diverter valve # 39725,-000 # 39720,-000** Not shown			Highflow thermostat # 34716,-000 Not shown	Thermostat with shut-off/diverter valve # 39725,-000 Not shown		
Axor® Carlton	Axor® Carlton	Axor® Montreux	Axor® Montreux				
							
Thermostat # 17710,-000,-090 # 17715,-000,-090***	Thermostat with shut-off valve # 17700,-000,-090 # 17705,-000,-090***	Thermostat # 16810,-000,-820	Thermostat with shut-off valve # 16800,-000,-820				
Highflow thermostat # 17712,-000,-090 # 17716,-000,-090*** Not shown	Thermostat with shut-off/diverter valve # 17720,-000,-090 # 17725,-000,-090*** Not shown	Highflow thermostat # 16815,-000,-820 Not shown	Thermostat with shut-off/diverter valve # 16820,-000,-820 Not shown				

* with integrated safety combination according to EN 1717, part 2.

** with lever handle.

*** with cross handle.

The Hansgrohe iBox universal is multi talented: it creates more space, freedom of movement and planning freedom in the bathroom – and is really quick and easy to install. Go to **www.pro.hansgrohe-int.com/ibox** to find out more about the iBox universal and its benefits



We did our utmost to ensure that the printing of this brochure was friendly to the environment. You too can contribute to the protection of our environment by passing on the brochure to others when you've finished reading it, or by recycling it.



PartnerPlus services:

Headquarters – Hansgrohe SE · Postbox 1145 · D-77757 Schiltach
Tel. +49 78 36 51-0 · Fax +49 78 36 51-13 00 · info@hansgrohe.com · www.hansgrohe-int.com

Australia – Hansgrohe Pty Ltd · Level 1, 123 Camberwell Rd, East Hawthorn · 3123 Victoria
Tel. +61 3 9811 9971 · Fax +61 3 9804 0042 · info@hansgrohe.com.au · www.hansgrohe.com.au

Cyprus – Hansgrohe Middle East & Africa Limited · PentadaktiLou Street 2 · Office 104
CY-7101 Larnaca (Aradippou) · Tel. +357 24 813081 · Fax +357 24 813031
me.support@hansgrohe.com · www.hansgrohe-middleeast.com

Estonia – Hansgrohe Eesti esindaja Andrus Asavi · Mäealuse 2/1 · 12618 Tallinn
Tel. +372 53 32 92 55 · Fax +372 56 00 00 55 · info@hansgrohe.ee · www.hansgrohe.ee

India – Hansgrohe India (pvt.) Ltd. · Office Nos. 601 - 604 · Sky Station
Viman Nagar · 411 016 Pune, Maharashtra · Tel. +91 20 6625 9595 · Fax. +91 20 6625 9599
info@hansgrohe.in · www.hansgrohe.in

Kazakhstan – Hansgrohe · Алматы · Бостандықский район · «Микрорайон КЕPEMEТ»,
дом № 1, часть А3 · телефон +7 (727) 315-09-16 · факс: +7 (727) 315-09-17
info@hansgrohe.kz · www.hansgrohe.kz

Latvia – Hansgrohe Latvijas pārstāvniecība · SIA Aqua Studio · Raiņa iela 14 · LV-3913 Iecava
Tel. +371 29 22 90 29 · Fax +371 63 94 22 51 · info@hansgrohe.lv · www.hansgrohe.lv

Lithuania – Santoza · Ulonų g. 5 · LT-08240 Vilnius
Tel. +370 5 2043291 · Fax +370 5 2043293 · info@hansgrohe.lt · www.hansgrohe.lt

Portugal – Hansgrohe · Showroom: Rua Antoine de Saint Exupéry Alapraia · P-2765-043 Estoril
Tel. +351 21 4667110 · Fax +351 21 4667119 · hansgrohe@jrbotas.com
www.hansgrohe-int.com · www.pro.hansgrohe-int.com

Singapore – Hansgrohe Pte Ltd. · 69 Mohamed Sultan Road · Singapore 239015 · Tel. +65 6884 5060
Fax +65 6884 5070 · info@hansgrohe.com.sg · www.hansgrohe.com.sg

South Africa – Hansgrohe South Africa (Pty) Ltd. · P.O Box 2912 · 136 Walton Road · Carlswald Midrand
ZA-1685 Halfway House · Tel. +27 11 468 11-50 · Fax +27 11 468 11-52
sales@hansgrohe.co.za · www.hansgrohe.co.za

Sweden – Hansgrohe AB · Svngatan 2B · 416 68 Göteborg
Tel. +46 31 216600 · Fax +46 31 190103 · info@hansgrohe.se · www.hansgrohe.se

