



## EOS

### Over-counter Wash-basin

59,3x39,5 cm.

REF: 34020

EOS rectangular over-counter wash-basin, without tap hole, and a soft design with rounded angles.

## REF 34020

### COLOURS/FINISHES

01  
White

### ARTICLES

Ref	Product/Set	Measurements	€/u
34020	Over-counter Wash-basin rectangular without tap hole	59,3 x 39,5 cm	
<b>Options</b>			
34025	Over-counter Wash-basin rectangular. Glazed on all four sides	60 x 40 cm	
34030	Over-counter Wash-basin oval without tap hole	59,3 x 39,5 cm	
34040	Over-counter Wash-basin square without tap hole	39,5 x 39,5 cm	
34050	Over-counter Wash-basin round without tap hole	Ø 39,5 cm	

### PRODUCT INFORMATION

#### Features

Over-counter Wash-basin 59,3 x 39,5 cm. rectangular / 13 kg. / 33 units pallet. Without tap hole.

#### Useful information

The over-counter Wash-basins are transformed into an exciting world of shapes, drawing curved, straight or oval lines, imagining sensual, elegant and modern spaces. Outlines and angles that create soft lines that adapt to different styles and settings.

#### Guarantee

Gala products are guaranteed against any manufacturing defects, from the date of purchase of the product, only if the installation has been carried out in accordance with Gala's installation instructions and, applying the current legislation on electrical and sanitary appliances, by authorised staff. The guarantee period for vitreous china is of 5 years.

#### Installation

Please check our product installation manuals.

#### Certificates

High quality is a constant at Gala in order to guarantee the technical and aesthetic features as well as the performance of our products. Please check our product quality certificates.

#### Maintenance

Cleaning should preferably be carried out using liquid detergent and a brush or sponge. Do not scrape with metal blades or steel scourer. Every six months it is advisable to check the wastepipe connections and check that there are no leaks.

### COMPLEMENTS



### SUGGESTIONS

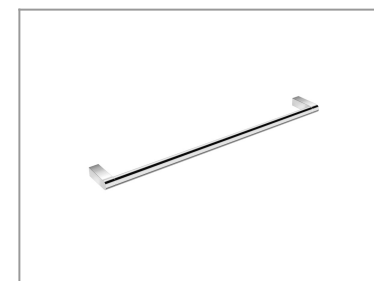

### SETTING







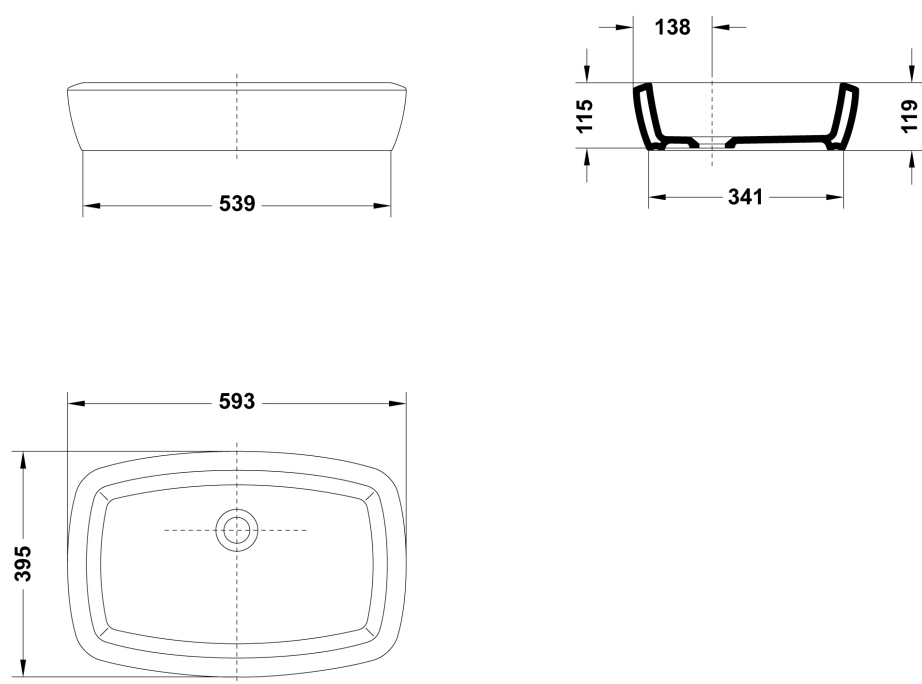



---



TECHNICAL DRAWINGS



## 2D

-  100.39 KB  Over-counter Wash-basin 59,3x39,5 cm. - Técnico (.AI)
-  194.04 KB  Over-counter Wash-basin 59,3x39,5 cm. - Técnico (.DWG)
-  506.48 KB  Over-counter Wash-basin 59,3x39,5 cm. - Técnico (.DXF)
-  110.01 KB  Over-counter Wash-basin 59,3x39,5 cm. - Técnico (.PDF)

## 3D

-  1.31 MB  Over-counter Wash-basin 59,3x39,5 cm. - 3D (.DWG)

**bimobject**

-  ArchiCAD 
-  Revit 